

**PERMANENT TEST STATIONS**

**Types and functions**

Document No.: 06-000-R2

Sheet: 1 of 1

*German Cathodic Protection*



Permanent test stations are installed at selected locations along the protected structure to test, monitor and control the performance of cathodic protection.

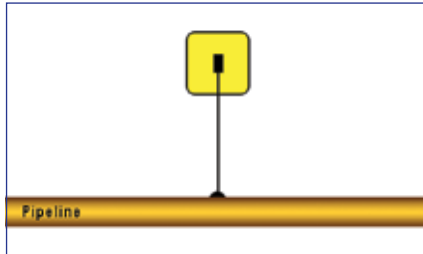

**Type - P -**  
For pipe-to-soil potential measurements

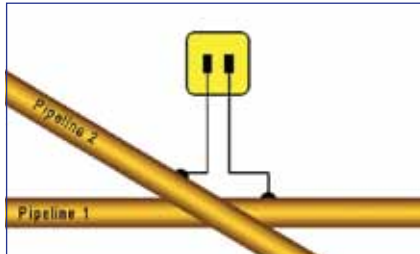

**Type - CR -**  
For checking interference between the protected pipeline and other pipelines or structures as well as pipe-to-soil potential measurements

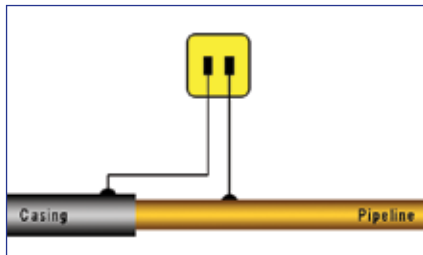

**Type - CA -**  
For checking the electrical isolation between pipeline and casing as well as pipe-to-soil potential measurements

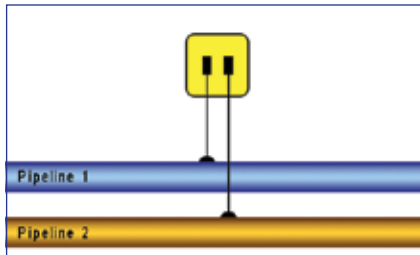

**Type - PB -**  
For electrical connection of isolated pipelines using a variable resistor as well as pipe-to-soil potential measurements

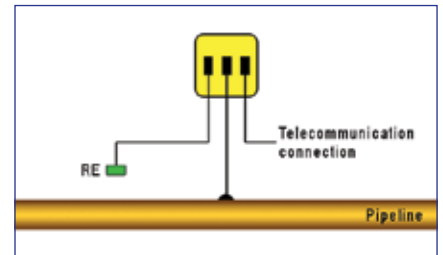

**Type - RM -**  
For remote monitoring of pipe-to-soil potential using transmitters

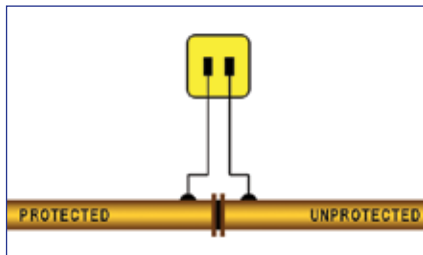

**Type - I -**  
For checking the efficiency of insulating flanges or joints as well as pipe-to-soil potential measurements

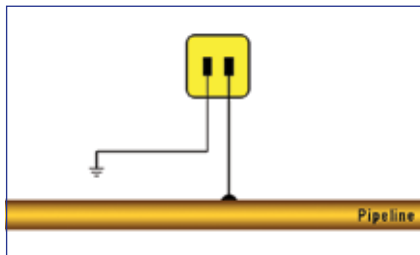

**Type - E -**  
For earthing the pipeline interfered by induced high voltage lines by means of lightning arresters as well as pipe-to-soil potential measurements

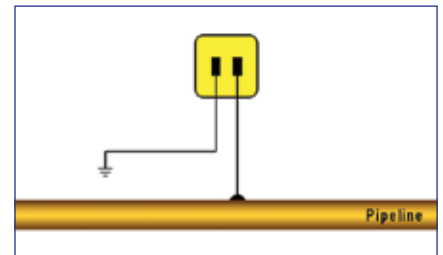

**Type - L -**  
For earthing the pipeline interfered by induced high voltage lines by means of diodes and condenser cascades as well as pipe-to-soil potential measurements

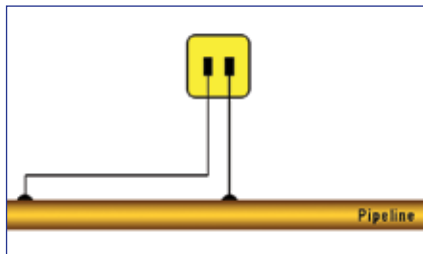

**Type - C -**  
For measurement of pipeline current as well as pipe-to-soil potential measurements

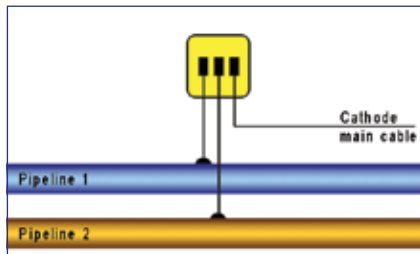

**Type - CJB -**  
For connection of pipelines or structures with different current requirements using diodes and variable resistors

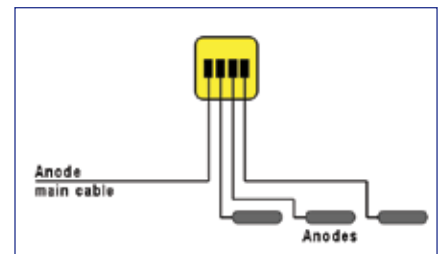

**Type - AJB -**  
For measuring and adjusting output current of individual string anodes using shunts and variable resistors

## PERMANENT TEST STATIONS

### Model: TP-001 and TP-002

Document No.: 06-100-R1

Sheet: 1 of 1

German Cathodic Protection



#### Model: TP-001

Model	Material	Length	Outside diameter
TP-001 S	Steel	1500 mm	approx. 108 mm

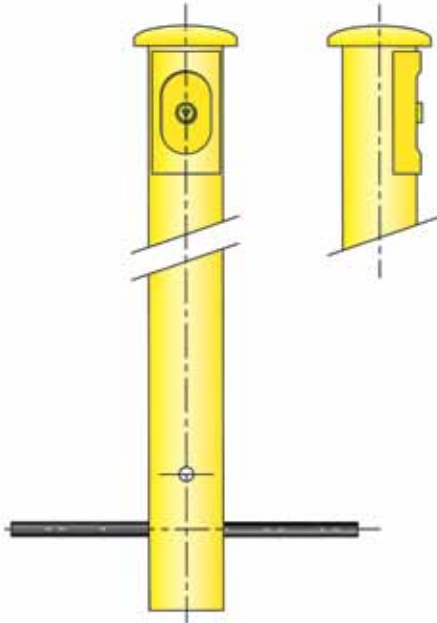

#### Model: TP-002

Model	Material	Length	Outside diameter
TP-002 S	Steel	3000 mm	approx. 108 mm
TP-002 P	Plastic	3000 mm	approx. 108 mm

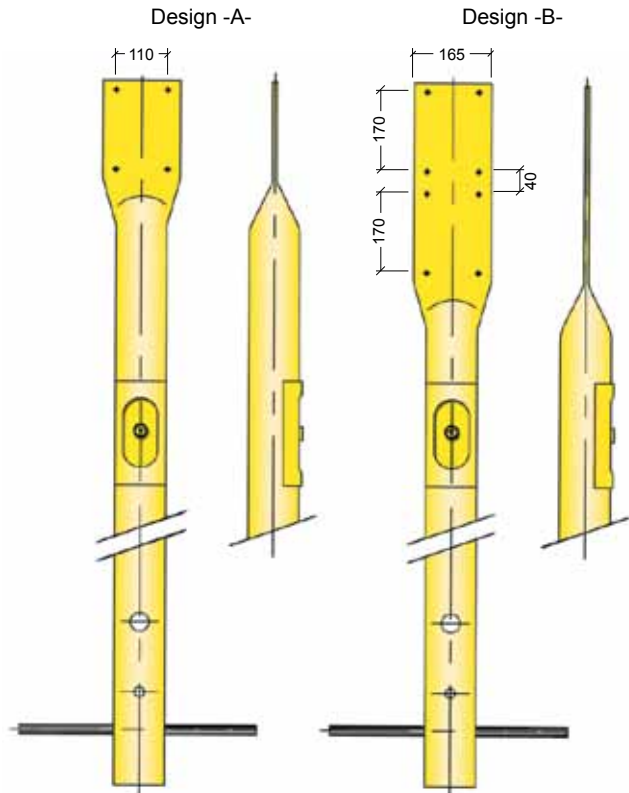

#### Specifications

- all steel parts painted with a two component epoxy resin paint, coating colour: yellow (RAL 1018)
- all PVC parts made of impact-resistant hard PVC coated with a layer of PMMA for UV-stability and durability of more than ten years
- termination lid provided with a triangular lock
- two PVC pipes on the lower part of the post for ground anchoring
- cable termination plate: 60x90 mm with 6 coloured spade terminals for cables upto 6 mm<sup>2</sup>
- cable conduit at the bottom of the post
- Model TP-001 with a top canopy for rain and weather protection
- Model TP-002 with a special flat top for fixing of TS identification plates

#### Optional features on request

- all steel parts hot galvanized
- main post of different lengths and colours
- additional higher rated spade terminals



## PERMANENT TEST STATIONS

Model: TP-003

Document No.: 06-200-R1

Sheet: 1 of 1

German Cathodic Protection



### Specifications

Extruded aluminium (AlMgSi) support posts with plain or yellow plastic coated finish, complete with aluminium caps and triangular locks. Posts available with choice of metal rod type ground anchor or slits for splayed anchorage.

Posts are also available in white (RAL 9010), grey (RAL 7001) or green (RAL 6005) plastic coated finish.

All posts can be marked with red fluorescent colour foil (fitted in accordance with enduser specifications).

Model	Finish	Length	Dia.	Terminal board design
TP 003 SPM 6/1500	plain aluminium	1 500 mm	60 mm	A, C or D
TP 003 SPM 6/2000	plain aluminium	2 000 mm	60 mm	A, C or D
TP 003 SPM 6/2500	plain aluminium	2 500 mm	60 mm	A, C or D
TP 003 SPMG 6/1500	yellow plastic coated	1 500 mm	60 mm	A, C or D
TP 003 SPMG 6/2000	yellow plastic coated	2 000 mm	60 mm	A, C or D
TP 003 SPMG 6/2500	yellow plastic coated	2 500 mm	60 mm	A, C or D
TP 003 SPM 10/1500	plain aluminium	1 500 mm	100 mm	B, C or D
TP 003 SPM 10/2000	plain aluminium	2 000 mm	100 mm	B, C or D
TP 003 SPM 10/2500	plain aluminium	2 500 mm	100 mm	B, C or D
TP 003 SPM 10/3000	plain aluminium	3 000 mm	100 mm	B, C or D
TP 003 SPMG 10/1500	yellow plastic coated	1 500 mm	100 mm	B, C or D
TP 003 SPMG 10/2000	yellow plastic coated	2 000 mm	100 mm	B, C or D
TP 003 SPMG 10/2500	yellow plastic coated	2 500 mm	100 mm	B, C or D
TP 003 SPMG 10/3000	yellow plastic coated	3 000 mm	100 mm	B, C or D



### Accessories

Fastening clamps designed for attaching aluminium base plates.  
Aluminium base plates for attaching identification signs.

### Termination plate/Terminal board design

- A Termination plate, made of PVC, 230 x 52 mm with 6 holes of 4.2 mm, spaced vertically
- B Termination plate, made of PVC, 300 x 90 mm with 8 holes of 4.2 mm, spaced vertically
- C Termination with vertical mounting rail accommodate up to 12 coupler terminals
- D Termination with horizontal mounting rail accommodate up to 4 coupler terminals

- A -



- B -



- C -



- D -

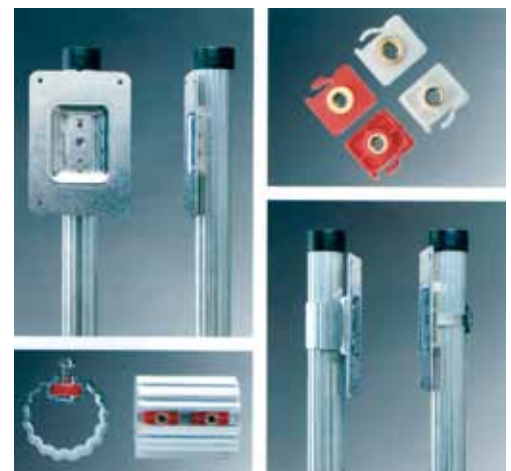

# PERMANENT TEST STATIONS

## Model: TP-004 and TP-005

Document No.: 06-300-R1

Sheet: 1 of 1

German Cathodic Protection



Model	Post	Termination cap	Length	Outside diameter
TP 004	Steel	Steel	1 600 mm	114.3 mm

### Standard features

- anti-vandalism design
- all parts made of mild steel, painted with a two component epoxy resin paint, coating colour: yellow (RAL 1018)
- cable termination plate covered by a removable cap. Cap can be fixed with three countersunk steel bolts.
- cable termination plate: 60 x 145 mm with 8 coloured spade terminals for cables up to 6 mm<sup>2</sup>
- a steel elbow for cable entry at the bottom of the tube
- delivery of test station without concrete foundation

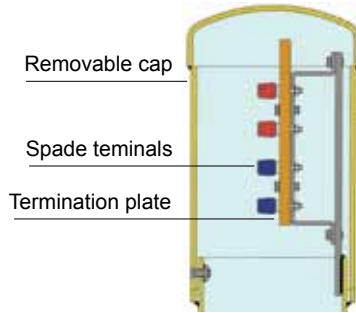

### Optional features on request

- main posts of different lengths and colours
- additional / higher rated spade terminals

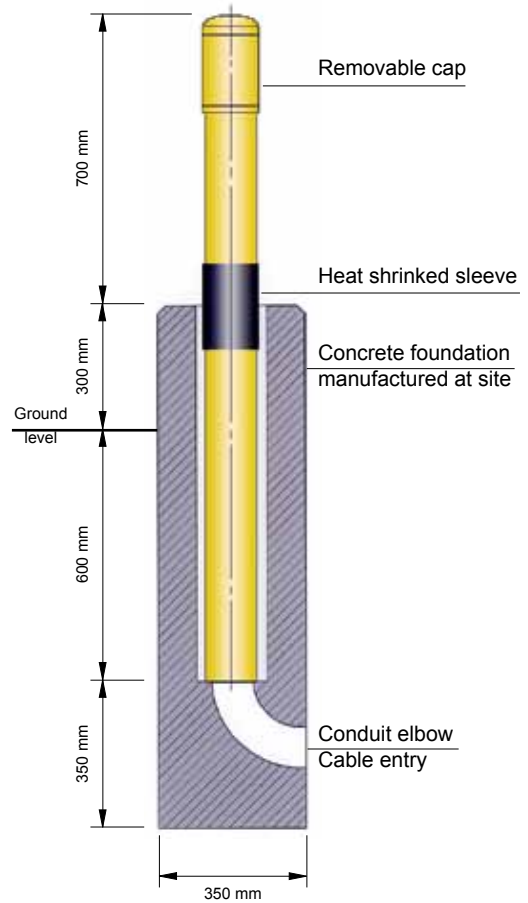

## Model: TP-005 (BIG FINK®)

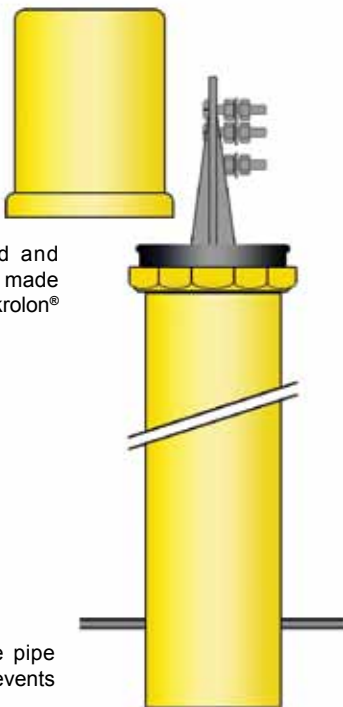

Cap, terminal board and compression nut are made of non-corrodable Makrolon® polycarbonate.

Anchor: polyethylene pipe on the lower post prevents removal.



Accessories: A BIG FINK® terminal boards can accommodate shunts, resistors, banana jacks, locking devices, lightning arrestors etc.

Colours: red, orange, yellow, green, blue, white and black are standard on BIG FINK® and support post.

Sizes: available in models to fit 1 1/4", 2" and 3" pipe.

Standard nickel plated brass or optional stainless steel terminals for guaranteed long service life. Up to 11 terminals accessible from both sides of the board.



## PERMANENT TEST STATIONS

Model: TP-006

Document No.: 06-400-R1

Sheet: 1 of 1

German Cathodic Protection



### Model: TP-006 (FLUSH FINK®)

- Flush mounting surface chamber for use in trouble some locations where water, street traffic and other adverse conditions exist. The chamber will maintain its structural integrity during hard usage and is suitable for installation in asphalted areas.
- The chamber can be used as a test station with 5 or 8 connections or as an access hole for placing reference cells.
- The chamber is made of non-corrodable durable glass filled polycarbonate that is resistant to ultraviolet radiation and guarantees dimensional and electrical stability between -15° C and 120° C.
- All electrical terminals are maintained in a dry environment even if the chamber is completely submerged.
- The terminals are completely accessible from both sides of the terminal board and the board can be easily removed from the housing and retrieved for easy access when taking test readings.
- Available with colour-coded lids in a choice of black, blue, red, orange, yellow, green, white. Other colours available on request.
- The lid is fitted with a metallic detector so that the unit can be located even it becomes completely covered , for example by asphalt.



Watertight bell, terminal board and housing are made from Makroblend® polycarbonate alloy. FLUSH FINK® is impervious to impact, traffic loads and chemical spills common to street usage.



Standard nickel plated brass or optional stainless steel terminals for guaranteed long service life. Up to 11 terminals accessible from both sides of the board.

Accessories:  
All FLUSH FINK® terminal boards can accommodate shunts, resistors, banana jacks, locking devices, lightning arrestors etc.

Support posts are made of PE (polyethylene). Optional polycarbonate is available for the toughest applications. Standard length: 1 foot - available to 40 feet with Cott's telescoping extender.



Dimensions:  
5 1/2" Diameter x 8" height fits 4" schedule 40 pipe

Anchor: polyethylene pipe on the lower post prevents removal.

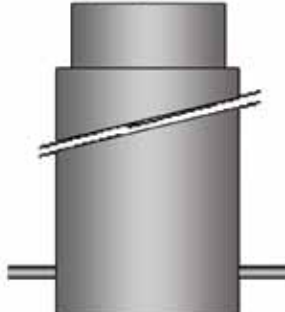

Model	No. of Terminals	Colour
FF-5-1	5	black
FF-5-2	5	blue
FF-5-3	5	red
FF-5-4	5	orange
FF-5-5	5	yellow
FF-5-6	5	green
FF-5-7	5	white
FF-8-1	8	black
FF-8-2	8	blue
FF-8-3	8	red
FF-8-4	8	orange
FF-8-5	8	yellow
FF-8-6	8	green
FF-8-7	8	white
FF-0-1	-	black
FF-0-2	-	blue
FF-0-3	-	red
FF-0-4	-	orange
FF-0-5	-	yellow
FF-0-6	-	green
FF-0-7	-	white

## PERMANENT TEST STATIONS

Model: TP-007

Document No.: 06-500-R1

Sheet: 1 of 1

German Cathodic Protection



Polycarbonate plastic housing in combination with aluminium stands for fully insulated test stations according to IP 43.

Special features are include:

- excellent UV and chemical resistance
- high elasticity, gradual brittleness begins only at temperatures below  $-90^{\circ}\text{C}$
- high ignition temperature ( $500^{\circ}\text{C}$ ) and self-extinguishing according to DIN 9102 and ASTM D 635

### Housing details

Model TP 104 KG1 / ZV  
(with a central locking system)

Housing model KG1 measures 494 x 134 x 120 mm. Standard colour is grey (RAL 7023). Downward opening housing lid.

Hinge with stainless steel pin, and top fasteners and two hexagon socket screws. Special identification plates can be attached to the lid.

Insulated termination plate made of durable PVC (or optional plexiglass) measuring 250 x 82 x 6 mm with eight 4.2 mm holes spaced horizontally and vertically at 40 mm intervals (or according to enduser specifications). The spade terminals are available in red, green, black, yellow or blue. The strain relief clamp is in the centre of the housing. The stand has a 130 x 45 mm hole for cable entry into the housing.

Model TP 104 KG2 / ZV  
(with a central locking system)

Model KG2 is similar to model KG1 but is designed for cable entry into the housing from below through a plastic or aluminium channel. (figure 3).

### Stands and cable channels

#### ALST1

Aluminium stand (AlMgSi 0.5) measures 120 x 50 x 1500 mm and has two threaded holes (M10) for installation of KG1 housing model. Cable entry through stand or rear of housing. (figure 1)



1

2

3

#### ALST2

Aluminium stand (AlMgSi 0.5) measures 120 x 50 x 1500 mm and has two threaded holes (M10) for mounting house model KG2. Two extra threaded holes (M6) are provided for attaching plastic or aluminium cable channels. Cable entry through cable channel and an opening in the lower face of the housing. (figure 3)

#### ALKK

Aluminium cable channel (AlMgSi 0.5) is made for installation on stand ALST2. Consisting of 1 piece measuring 50 x 120 mm for a total length of 600 mm. (figure 2)

#### KUKK

Plastic cable channel (polycarbonate) is made for installation on stand model ALST2; consisting of two pieces measuring 110 x 52 mm for a total length of 680 mm. (figure 3)

## PERMANENT TEST STATIONS

### Model: AJB (Anode Junction Box)

Document No.: 06-600-R1

Sheet: 1 of 1

German Cathodic Protection



Anode Junction Boxes AJBs provide terminations for anodes and cables and connections to the main positive cable from the DC power source unit.

AJBs can be equipped with shunts to control the output current of individual anodes (or group of anodes), as well as variable resistors for individual adjustment of anode circuit output current.

Tailor-made anode junction boxes are provided with all necessary components such as:

- variable resistors according to required ratings
- shunts according to required ratings and standards
- cable terminations for cable lugs or screw clamp connections
- cable glands or conduits for cable entries

### Robust aluminium enclosures

#### Technical Data

Material:	DIN EN 1706 EN AC-AISI 12 (Fe)
Painting:	Powder coating
Colour:	RAL 7001, silver grey special colours on request
Ingress protection :	IP 66 to EN 60529
Impact resistance:	> 7 Joule; EN 50014
Temperature resistance:	PUR-(polyurethane) seal (standard) -40° C to +90° C CR-(chloroprene) seal -40° C to +100° C VMQ-(silicone) seal (optional) -60° C to +130° C

Enclosures also available in polyester or stainless steel for outdoor/weatherproof installation according to IP66, or in range of EX versions for use in hazardous areas. Other enclosures can be custom manufactured and tested according to applicable standards and enduser specification.



Enclosure



External brackets



External hinge



Internal hinge

### Accessories

DIN rail, earthing rail, mounting plate, external brackets, external aluminium hinges, quick lock internal hinges, Turn bolt fastener, etc.

### Options

Hot-dipped galvanised steel supports for installation on concrete foundations or supports for wall mounting with conduits, etc. available on request.



Steel support mounted AJB on concrete foundation at anode deep grounded structure (with crash barriers)

### Anode Junction Box - Typical Layout

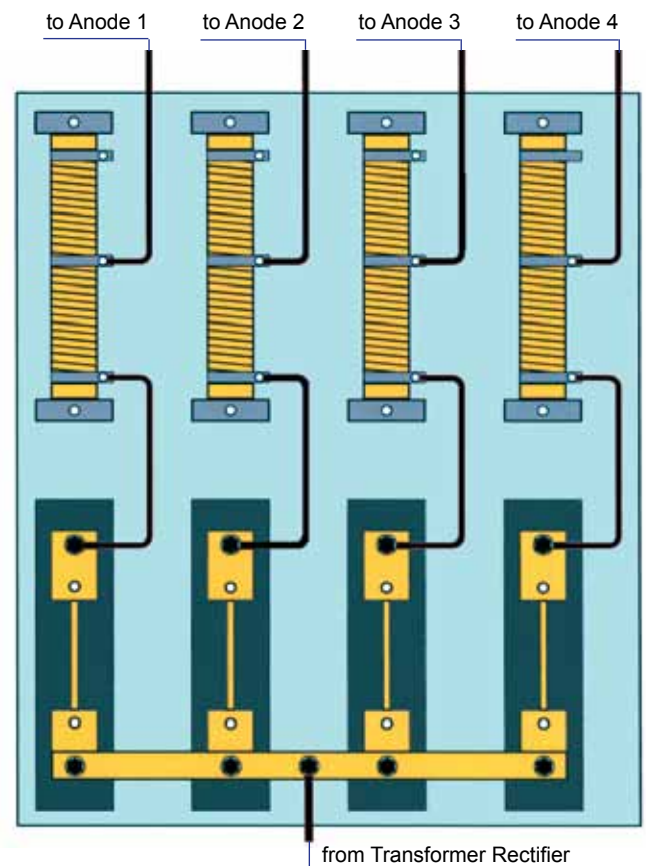

## Permanent Test Stations

### Model: CJB (Cathode Junction Box)

Document No.: 06-700-R2

Sheet: 1 of 1

German Cathodic Protection



Where a common impressed current cathodic protection system is applied to several separate metallic structures, it may be necessary to adjust or to balance the flow of protective current between the protected structures by means of a Cathode Junction Box.

Tailor-made anode junction boxes are provided with all necessary components such as:

- variable resistors for the adjustment of currents
- shunts for measurement of currents
- blocking diodes to prevent the flow of currents in reverse direction
- terminals for cable lug or screw clamp connections
- cable glands or conduits for cable entries

### Robust aluminium enclosures

#### Technical Data

Material:	DIN EN 1706 EN AC-AISI 12 (Fe)
Painting:	Powder coating
Colour:	RAL 7001, silver grey special colours on request
Ingress protection :	IP 66 to EN 60529
Impact resistance:	> 7 Joule; EN 50014
Temperature resistance:	PUR-(polyurethane) seal (standard) -40° C to +90° C CR-(chloroprene) seal -40° C to +100° C VMQ-(silicone) seal (optional) -60° C to +130° C

Enclosures also available in polyester or stainless steel for outdoor/weatherproof installation according to IP66, or in range of EX versions for use in hazardous areas. Other enclosures can be custom manufactured and tested according to applicable standards and enduser specification.

### Accessories

DIN rail, earthing rail, mounting plate, external brackets, external aluminium hinges, quick lock internal hinges, Turn bolt fastener, etc.

### Options

Hot-dipped galvanised steel supports for installation on concrete foundations or supports for wall mounting with conduits, etc. available on request.



CJB with hot-dipped galvanised steel supports

### Cathode Junction Box - Typical Layout

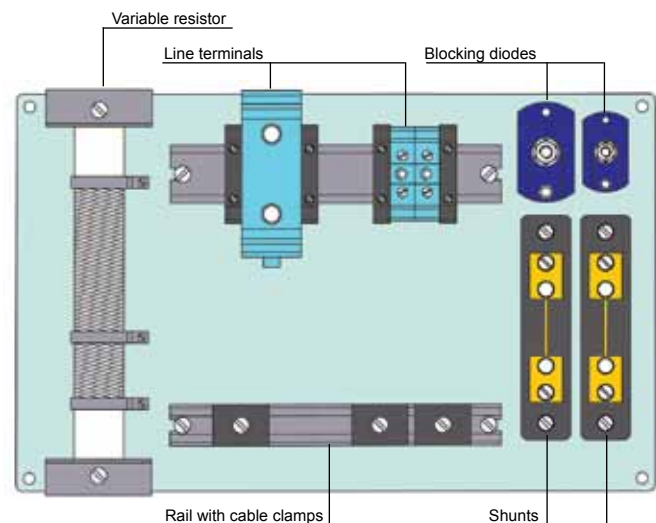

Enclosure



External brackets



External hinge



Internal hinge



## PERMANENT TEST STATIONS

### Model: AJBex (Anode Junction Box ex)

Document No.: 06-610-R0

Sheet: 1 of 2

German Cathodic Protection



Anode Junction Boxes AJBs provide terminations for anodes and cables and connections to the main positive cable from the DC power source unit.

AJBs can be equipped with shunts to control the output current of individual anodes (or group of anodes), as well as variable resistors for individual adjustment of anode circuit output current.

Tailor-made anode junction boxes are provided with all necessary components such as:

- variable resistors according to required ratings
- shunts according to required ratings and standards
- cable terminations for cable lugs or screw clamp connections
- cable glands or conduits for cable entries

### EJB Series enclosures - galvanized carbon steel

EJB.. series enclosures offers Ex-d IIB or IIB+H2 mode of protection.

They are suitable for hazardous areas of industrial plants for indoor and outdoor applications.

#### Specifications

Material	Stainless steel AISI316L
Ambient temperature	50°C to +55°C -20°C to +55°C (IECEX Certificate)
Approvals	INERIS 00ATEX0021X GOST R IECEX INE 10.0015X INMETRO
Marking	II 2 GD Ex-d IIB T(**) Gb or Ex-d IIB+H2 T(**) Gb Ex-tb IIIC T(**) Db IP65 or 66 or 67 ** T6/T85°C, T5/T100°C, T4/T135°C, T3/T200°C II 2(1) GD Ex-d [ja Ga] IIB T6 Gb or Ex-d [ja Ga] IIB+H2 T6 Gb Ex-tb [ja Da] IIIC T85°C Db IP65 or 66 or 67 II 2(2) GD Ex-d [ib] IIB T6 Gb or Ex-d [ib] IIB+H2 T6 Gb Ex-tb [ib] IIIC T85°C Db IP65 or 66 or 67 NOTE: under IEC Ex directive, enclosures are suitable for IIB group of gases/dusts only
Surface treatment	Unpainted
Entries	Metric pitch 1.5, ANSI B1.20.1 NPT, UNI-6125
Standard certificate label	Made by self adhesive UV and corrosion resistant polyester, approved by INERIS Laboratory.
Accessories available upon request	Drain/breather valve Door handle External polyurethane painting cycle Internal anticondensate painting Traffolyte/Stainless steel certificate label



#### Anode Junction Box - Typical Layout

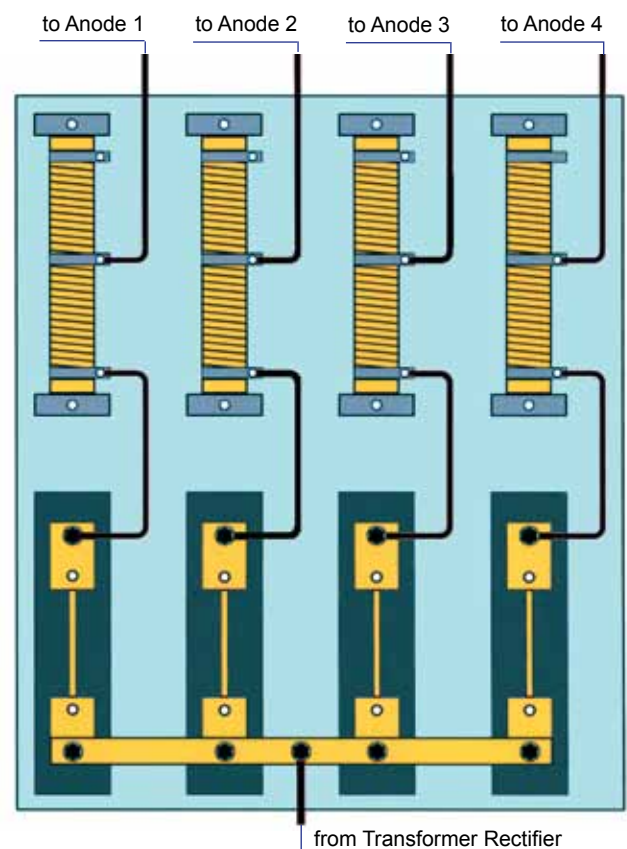

**PERMANENT TEST STATIONS****Model: AJBex (Anode Junction Box ex)****German Cathodic Protection**

Document No.: 06-610-R0

Sheet: 2 of 2

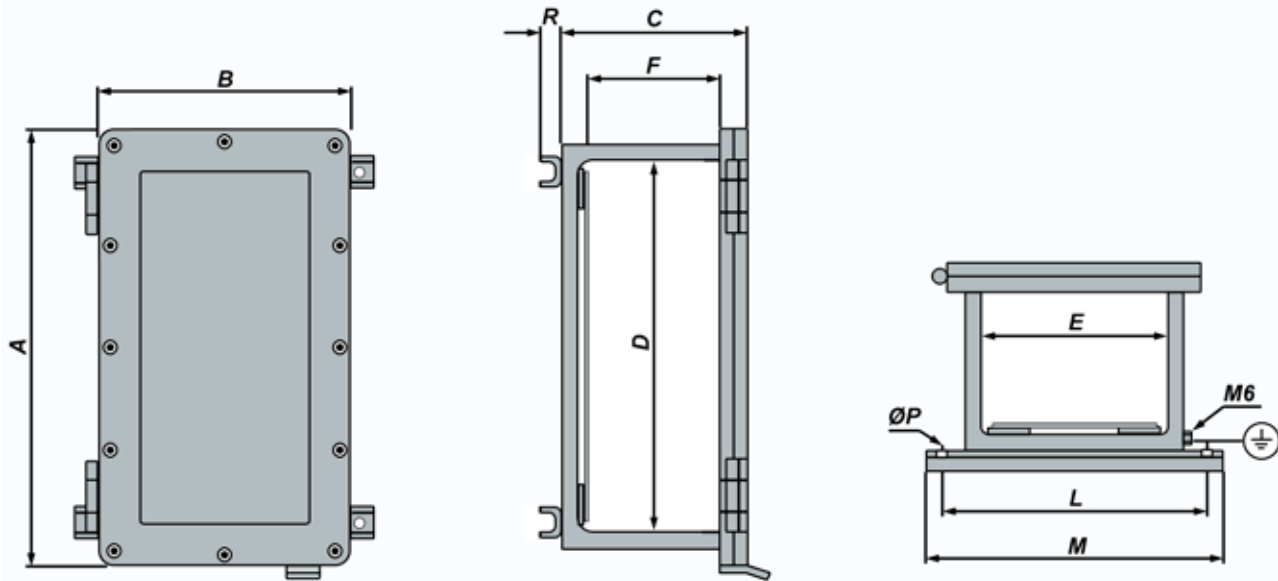
**EJB.. Series enclosures c/w internal mounting plate, mounting brackets, hinges - AISI316L**

TYPE	DIMENSIONS										WEIGHT [KG]	AA**	PLATE
	A	B	C	D	E	F	L	M	ØP	R			
EJB-2	298	238	174	230	168	95	250	280	M6	20	35	12	160 x 220
EJB-3	412	238	177	340	167	85	250	280	M8	20	45	18	155 x 330
EJB-4	418	302	175	335	220	90	300	320	M8	20	56	20	210 x 325
EJB-5	480	300	232	392	209	125	300	320	M8	20	70	22	200 x 385
EJB-6	483	408	238	387	310	130	390	420	M8	20	62	28	300 x 380
EJB-8	634	365	254	530	262	140	340	370	M8	20	114	36	250 x 520
EJB-9	535	468	257	426	363	140	440	470	M10	20	118	34	350 x 420
EJB-11	596	505	267	483	394	130	480	510	M10	20	139	44	380 x 470
EJB-12	805	455	310	690	335	170	425	450	M12	20	181	54	325 x 625
EJB-13	832	607	314	723	500	115	580	620	M12	20	235	76	463 x 683
EJB-13A	832	607	400	723	500	205	580	620	M12	20	261	76	463 x 683

\*\*Maximum quantity of operators on door.

Note: For installations in either Zone 1 or volume up to 2dm<sup>3</sup>, barrier glands are required.  
Please refer to EN-60079-14.

## Permanent Test Stations

### Model: CJBex (Cathode Junction Box ex)

Document No.: 06-710-R0

Sheet: 1 of 2

German Cathodic Protection



Where a common impressed current cathodic protection system is applied to several separate metallic structures, it may be necessary to adjust or to balance the flow of protective current between the protected structures by means of a Cathode Junction Box.

Tailor-made anode junction boxes are provided with all necessary components such as:

- variable resistors for the adjustment of currents
- shunts for measurement of currents
- blocking diodes to prevent the flow of currents in reverse direction
- terminals for cable lug or screw clamp connections
- cable glands or conduits for cable entries

### EJB Series enclosures - galvanized carbon steel

EJB.. series enclosures offers Ex-d IIB or IIB+H2 mode of protection.

They are suitable for hazardous areas of industrial plants for indoor and outdoor applications.

#### Specifications

Material	Stainless steel AISI316L
Ambient temperature	50°C to +55°C -20°C to +55°C (IECEX Certificate)
Approvals	INERIS 00ATEX0021X GOST R IECEX INE 10.0015X INMETRO
Marking	II 2 GD Ex-d IIB T(**) Gb or Ex-d IIB+H2 T(**) Gb Ex-tb IIIC T(**) Db IP65 or 66 or 67 ** T6/T85°C, T5/T100°C, T4/T135°C, T3/T200°C II 2(1) GD Ex-d [ja Ga] IIB T6 Gb or Ex-d [ja Ga] IIB+H2 T6 Gb Ex-tb [ja Da] IIIC T85°C Db IP65 or 66 or 67 II 2(2) GD Ex-d [ib] IIB T6 Gb or Ex-d [ib] IIB+H2 T6 Gb Ex-tb [ib] IIIC T85°C Db IP65 or 66 or 67 NOTE: under IEC Ex directive, enclosures are suitable for IIB group of gases/dusts only
Surface treatment	Unpainted
Entries	Metric pitch 1.5, ANSI B1.20.1 NPT, UNI-6125
Standard certificate label	Made by self adhesive UV and corrosion resistant polyester, approved by INERIS Laboratory.
Accessories available upon request	Drain/breather valve Door handle External polyurethane painting cycle Internal anticondensate painting Traffolyte/Stainless steel certificate label

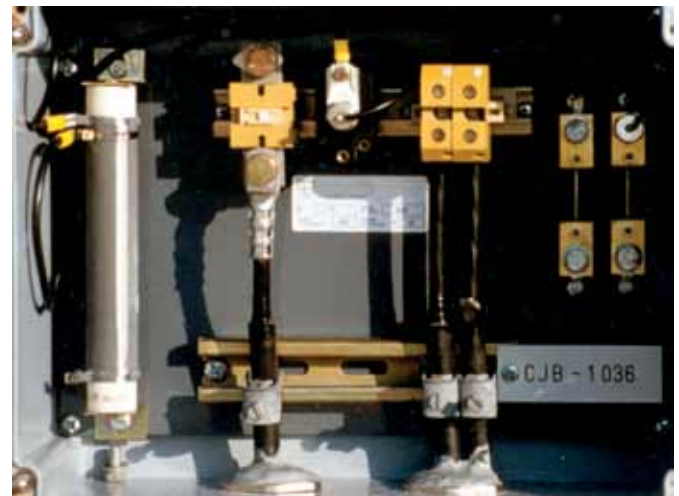

### Cathode Junction Box - Typical Layout

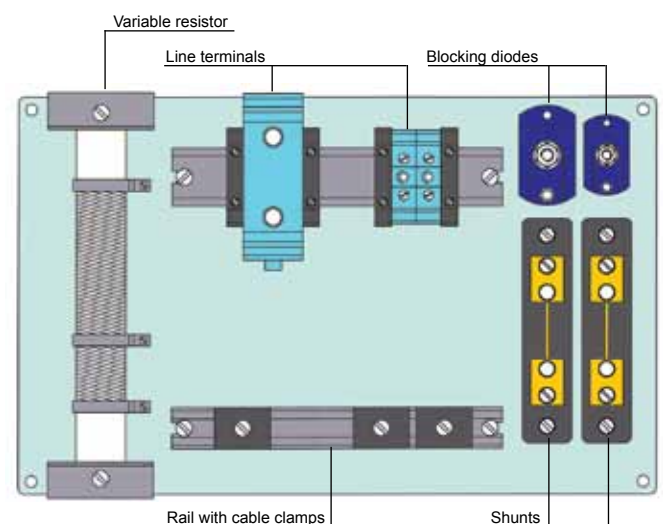

**EJB.. Series enclosures c/w internal mounting plate, mounting brackets, hinges - AISI316L**

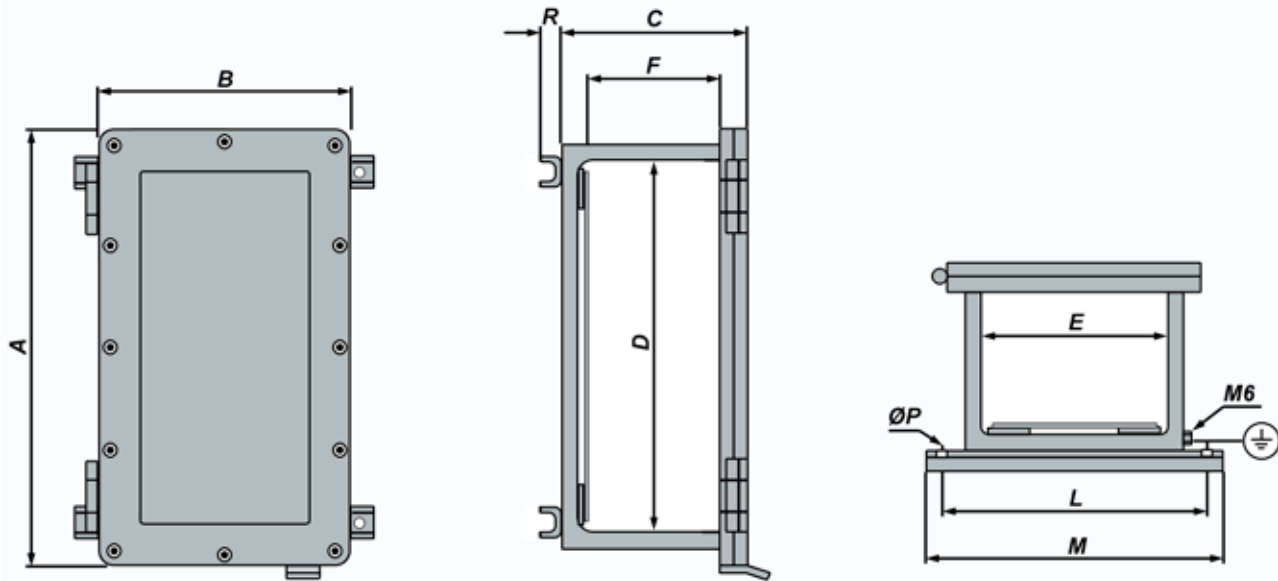

TYPE	DIMENSIONS										WEIGHT [KG]	AA**	PLATE
	A	B	C	D	E	F	L	M	ØP	R			
EJB-2	298	238	174	230	168	95	250	280	M6	20	35	12	160 x 220
EJB-3	412	238	177	340	167	85	250	280	M8	20	45	18	155 x 330
EJB-4	418	302	175	335	220	90	300	320	M8	20	56	20	210 x 325
EJB-5	480	300	232	392	209	125	300	320	M8	20	70	22	200 x 385
EJB-6	483	408	238	387	310	130	390	420	M8	20	62	28	300 x 380
EJB-8	634	365	254	530	262	140	340	370	M8	20	114	36	250 x 520
EJB-9	535	468	257	426	363	140	440	470	M10	20	118	34	350 x 420
EJB-11	596	505	267	483	394	130	480	510	M10	20	139	44	380 x 470
EJB-12	805	455	310	690	335	170	425	450	M12	20	181	54	325 x 625
EJB-13	832	607	314	723	500	115	580	620	M12	20	235	76	463 x 683
EJB-13A	832	607	400	723	500	205	580	620	M12	20	261	76	463 x 683

\*\*Maximum quantity of operators on door.

Note: For installations in either Zone 1 or volume up to 2dm<sup>3</sup>, barrier glands are required. Please refer to EN-60079-14.

## PERMANENT TEST STATIONS

### Accessories

Document No.: 06-800-R1

Sheet: 1 of 1

German Cathodic Protection



### Aerial Line Markers

Aerial line markers are available in a wide range of shapes, sizes and colours. Reflective film can be applied to the entire surface or as cutout segments.

#### Materials

Plastics made of PMMA- ASA - and glassfibre reinforced polyester, for UV resistance and excellent reflective properties.

Other materials, special dimensions and other colours, not shown here are available on request.

#### Accessories

Fasteners or brackets and all required screws, nuts and washers are included, letters and figures made of black, weatherproof plastic are available from A-Z and 0-9.

#### Dimensions



Type	50	51	60	70	90	100	110
Roof area	335 x 230 mm	350 x 230 mm	500 x 330 mm	400 x 300 mm	440 mm Ø	500 mm Ø	600 mm Ø
Roof pitch	45°	45°	60°	45°	--	--	--
Roof position	90° rotatable	90° rotatable	15° rotatable	90° rotatable	--	--	--
Material thickness	5 mm	5 mm	5 mm	5 mm	5 mm	5 mm	5 mm
Material colour	e.g. yellow, red	e.g. yellow, red	e.g. yellow, red	e.g. yellow, red	e.g. yellow, red	e.g. yellow, red	e.g. yellow, red



### Identification Plates

Identification plates according to DIN-standard made of a two colour injection-moulded plate in ASA Thermoplast (Luran S), which resists extreme weather, temperatures and shocks.

Non-reflective matt surfaces guarantee excellent readability even at long distances.

Plate are securely fastened by 4 countersunk stainless steel (V2a) screws in flush mounts.

They can be fitted with either SGM inserts or any other inserts currently being produced by any manufacturer.

Identification plates to other international standards as well as the corresponding accessories in various sizes, colours, materials and inscriptions available upon request.

