









# SACRIFICIAL ANODES

## Selection Guide

Our DECP™ software package has been specially designed to solve the planning problems, assist with correct material selection and for optimum system configuration.

		ANODES												
		Mg prepacked w. backfill	Fresh water Mg	Hull Mg	Hull Al	Hull Zn	Offshore Al	Offshore Zn	Tank Al	Tank Zn	Ribbon zinc	Ribbon magnesium	Bracelet aluminium	Bracelet zinc
		<input checked="" type="checkbox"/>									<input checked="" type="checkbox"/>	<input checked="" type="checkbox"/>		
<b>PIPELINE OFFSHORE</b>													<input checked="" type="checkbox"/>	<input checked="" type="checkbox"/>
		<input checked="" type="checkbox"/>									<input checked="" type="checkbox"/>	<input checked="" type="checkbox"/>		
<b>CASING INTERNAL</b>											<input checked="" type="checkbox"/>	<input checked="" type="checkbox"/>		
<b>TANKS INTERNAL</b>			<input checked="" type="checkbox"/>						<input checked="" type="checkbox"/>	<input checked="" type="checkbox"/>				
			<input checked="" type="checkbox"/>	<input checked="" type="checkbox"/>			<input checked="" type="checkbox"/>	<input checked="" type="checkbox"/>						
<b>OFFSHORE STRUCTURES / SHIPPING</b>					<input checked="" type="checkbox"/>	<input checked="" type="checkbox"/>	<input checked="" type="checkbox"/>	<input checked="" type="checkbox"/>						
			<input checked="" type="checkbox"/>	<input checked="" type="checkbox"/>	<input checked="" type="checkbox"/>	<input checked="" type="checkbox"/>	<input checked="" type="checkbox"/>	<input checked="" type="checkbox"/>	<input checked="" type="checkbox"/>	<input checked="" type="checkbox"/>				
<b>INTERNAL PROTECTION</b>			<input checked="" type="checkbox"/>	<input checked="" type="checkbox"/>	<input checked="" type="checkbox"/>	<input checked="" type="checkbox"/>	<input checked="" type="checkbox"/>	<input checked="" type="checkbox"/>	<input checked="" type="checkbox"/>	<input checked="" type="checkbox"/>				
<b>WATER WELL RISER PIPES</b>			<input checked="" type="checkbox"/>								<input checked="" type="checkbox"/>	<input checked="" type="checkbox"/>		

# SACRIFICIAL ANODES

## Magnesium anodes

Document No.: 05-100-R1

Sheet: 1 of 2

German Cathodic Protection



### Prepackaged magnesium anodes

Magnesium anodes for buried pipelines, casings, tanks and similar structures are prepacked either in cotton bags or cardboard cartons containing a rapid wetting, moisture retaining backfill.

The backfill powder reduces the resistivity of soil surrounding the anodes and improves their anode performance.

The pre packaged magnesium anodes are available in two grades, Standard and High Potential, which is used primarily in high resistivity soils.

Anodes are supplied with 5 m (PVC/PVC) insulated copper cable of 6 mm<sup>2</sup> as standard, other sizes and lengths are available on request.

MAGNESIUM		
Composition	%	
	Standard	High Potential
Al	5.50 - 6.50	0.003
Zn	2.50 - 3.50	0.004
Mn	0.20 - 0.50	0.50 - 1.00
Cu	0.002	0.002
Ni	0.001	0.002.
Fe	0.005	0.025 max.
Others	0.01	0.005
Mg	remainder	remainder
Potential Cu/CuSO <sub>4</sub>	-1.60 V	-1.75 V
Max. capacity	1250 Ah / kg	1250 Ah / kg

Type	Weight (nominal)		Anode Dimensions				
	Bare	Packaged	W	H	L	Ø D	OL
	kg	kg	mm	mm	mm	mm	mm
3D3	1.4	3.6	89	95	127	152	254
3D5	2.3	7.7	89	95	216	152	305
9D3	4.1	12.2	89	95	356	152	432
17D3	7.7	20.4	89	95	654	191	864
20D2	9.1	31.8	70	76	1518	127	1676
32D5	14.5	31.8	140	127	521	203	711
32D3	14.5	41.3	89	95	1149	165	1346
40D3	18.1	43.5	89	95	1518	165	1676
48D5	21.8	45.4	140	146	787	203	965
4x4x60	27.2	56.7	102	102	1524	176	1626

Standard backfill composition:

- Powdered Gypsum : 75 %
- Granular Bentonite : 20 %
- Sodium Sulphate : 5 %

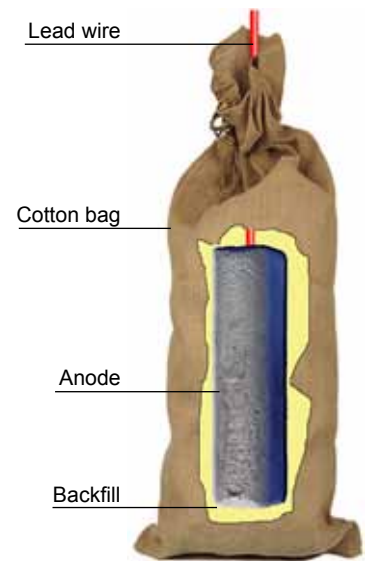
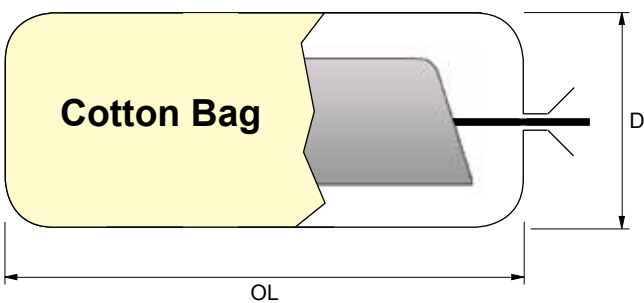
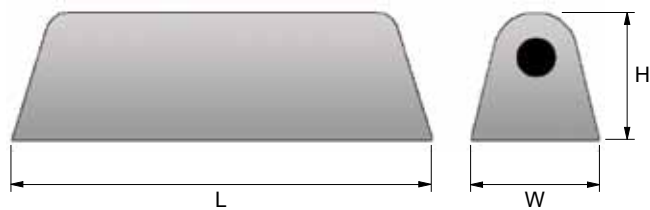

All weights and dimensions are nominal and subject to variation in material compositions. Alternative configurations may be cast to requirements.

# SACRIFICIAL ANODES

## Magnesium anodes

Document No.: 05-100-R1

Sheet: 2 of 2

German Cathodic Protection



MAGNESIUM		
Composition	%	
	Standard	High Potential
Al	5.30 - 6.70	0.05
Zn	2.50 - 3.50	0.03
Mn	0.25 min.	0.50 - 1.50
Cu	0.08	0.02
Ni	0.001	0.002
Fe	0.005 max.	0.002 max.
Si	0.03 max.	0.05 max.
Mg	remainder	remainder
Potential Cu/CuSO <sub>4</sub>	-1.60 V	-1.75 V
Max. capacity	1230 Ah / kg	1230 Ah / kg

A range of magnesium anodes suitable for marine structures, storage tanks and condenser boxes is available in either high purity or high potential alloys.

All weights and dimensions are nominal and subject to variation in material compositions. Alternative configurations may be cast to requirements.

Type	A	B	C	D	E	F	G	H	J	Weight
MG46M	864	232	120	102	108	610	90	50	6	20.8 kg
MG73M	864	232	152	127	130	610	90	50	12	33.0 kg

All dimensions in mm

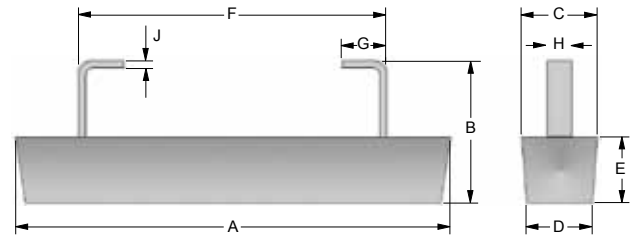

Type	Diameter A	Length B	Weight
MG101	82	381	3.6
MG102	114	457	7.7
MG103	114	533	10.0
MG104	146	533	15.5
MG104M	146	508	14.5
MG105	178	508	22.7
MG105M	178	610	27.3
MG106	114	1524	27.3

MG101 to MG105: mild steel insert - 20 x 20 x 3 mm strip  
MG106: angle section insert - 20 x 20 x 3 mm

Type	A	B	C	D	Weight
MG119			89		
MG123	114	533	89	89	10.0 kg
MG120			89		
MG124	146	532	89	89	15.5 kg
MG121			89		
MG125	178	508	89	89	22.7 kg

MG119-MG121 (core at one end only)  
MG123-MG125 (core at both ends)

All dimensions in mm

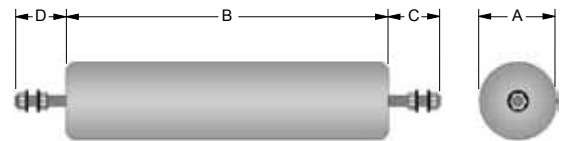
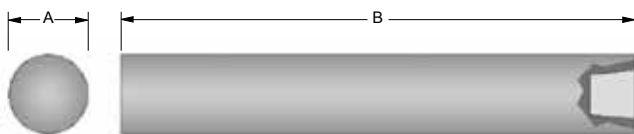

Type	A	B	C	D	E	F	G	H	Weight
MG128	571	219	368	298	50	9	12	16	68.0 kg
MG129	597	279	432	298	50	9	12	16	90.7 kg

Type	Dia. A	Dia. B	C	D	E	Galvanised core details	Weight
MG107	57	70	-	19	32	1/2" B.S.P.	0.56 kg
MG107M	76	89	-	19	32	1/4" Whitworth	1.0 kg
MG108A	120	108	76	-	-	M12 thread	1.8 kg
MG108B	120	108	-	19	32	3/4" B.S.P.	1.8 kg
MG108B (mod)	120	108	-	19	32	3/4" B.S.P. insert (located in diagram A)	1.8 kg

H = Dia. Galv. M.S. Eye-bolt

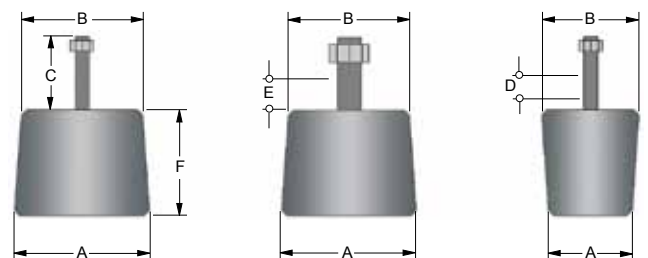
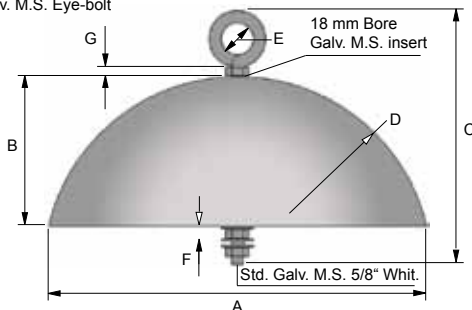

# SACRIFICIAL ANODES

## Zinc anodes

Document No.: 05-200-R1

Sheet: 1 of 2

German Cathodic Protection



### Standard Zinc Hull Anodes

Type	Anode weight kg	Zinc weight kg	A mm	B mm	H mm	L mm
2	0.25	0.21	100	35	15	132
5	0.5	0.44	120	46	23	160
10	1.0	0.90	140	62	28	210
20	2.0	1.90	180	90	30	210
35	3.5	3.20	220	100	29	300
55	5.5	5.10	268	110	32	350
102	10.2	9.30	350	150	32	450
155	15.5	14.70	600	120	44	700
235	23.5	22.20	960	120	39	1060

All weights and dimensions are nominal and subject to variation in material compositions. Alternative configurations may be cast to requirements.

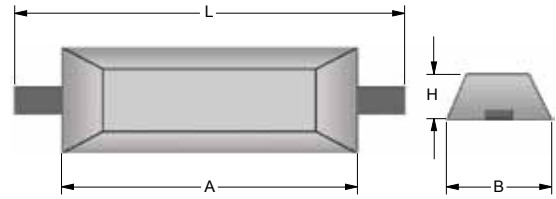

Type	Anode weight kg	Zinc weight kg	A mm	B mm	H mm	L mm
22	2.2	2.1	230	77	32	300
105	10.5	9.6	405	220	35	445
145	14.5	13.5	405	220	45	445

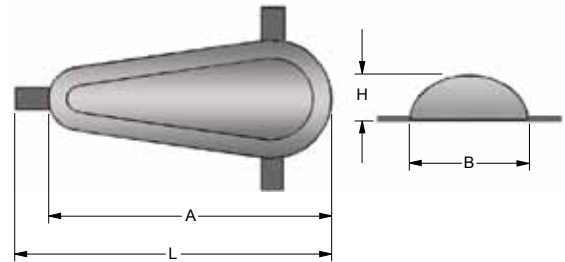

### Standard Zinc Tank Anodes

Type	Anode weight kg	Zinc weight kg	B mm	H mm	OH mm	L mm
50T	5.0	4.4	47	40	140	400
105T	10.0	9.4	70	60	140	400

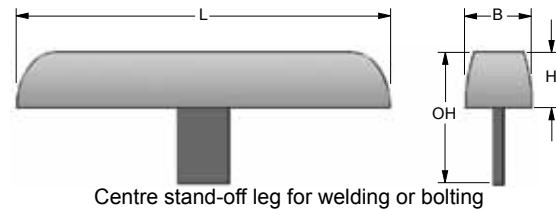

Double cranked or straight core						
Type	Anode weight kg	Zinc weight kg	A mm	B mm	H mm	L mm
140T	14.0	12.6	1235	40	40	1365
225T	22.5	20.3	1235	50	50	1415
305T	30.5	28.3	1235	58	58	1415

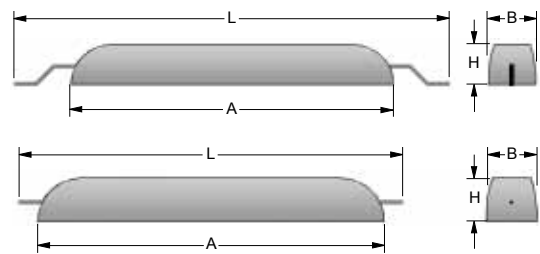

Extending core Ø 12 mm  
Extending core Ø 16 mm  
Extending core Ø 25 mm

Type	Anode weight kg	Zinc weight kg	B mm	H mm	OH mm	L mm
220T	22.0	20.2	64	51	145	1235
300T	30.0	28.2	68	58	145	1235
450T	45.0	42.7	76	63	150	1600
500T	50.0	48.1	78	68	150	1600
570T	57.0	55.0	86	66	150	1600

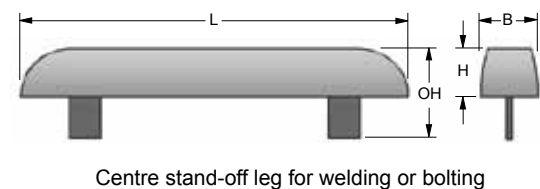

All anodes can be delivered with clamps for weld-free mounting

**Standard Zinc Anodes for Cooling Systems**

Type	Anode weight kg	Diameter mm	L mm
12 K/33	0.03	12	30
12 K/90	0.07	12	90
12 K300	0.25	12	300
13 K	0.05	13	56

With Ø 5 mm core, M5, extending 10 mm

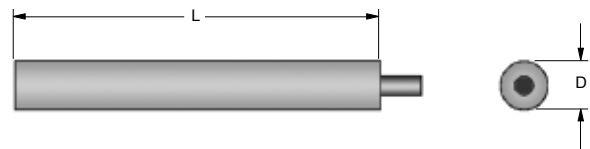

With 3/8" WG, extending 10 mm



Type	Anode weight kg	Diameter mm	L mm
17 K	0.5	17	300
22 K	0.5	22	200
28 K	1.7	28	400
30 K	1.6	30	320
40 K	2.0	40	215
50 K	2.9	50	215
60 K	4.5	60	215
70 K	5.8	70	215
80 K	7.5	80	215

with Ø 5 mm core or without core  
 with Ø 5 mm core or without core  
 with Ø 5 mm core or without core  
 with Ø 5 mm core or without core  
 with Ø 5 mm core or without core  
 with Ø 1/4" tube core or without core  
 with Ø 3/8" tube core or without core  
 with Ø 3/8" tube core or without core  
 with Ø 1/2" tube core or without core

With Ø 3/4" tube core, extending 25 mm or without core

Type	Anode weight kg	Diameter mm	H mm
78 K	1.2	78	45
140 K	2.5	140	25
180 K	4.2	180	25
200 K	5.1	200	25

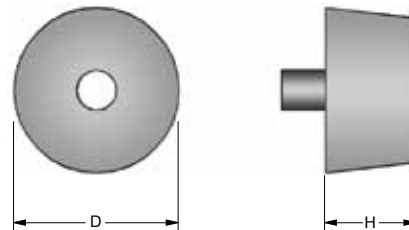

Type	Anode weight kg	L mm	B mm	H mm
KBS 1	1.5	240	45	20
KBS 2	2.0	190	100	15
KBS 3	7.1	220	150	30
KBS 4	7.0	220	130	34
KBS 5	0.9	170	50	15
KBS 6	0.3	120	50	12

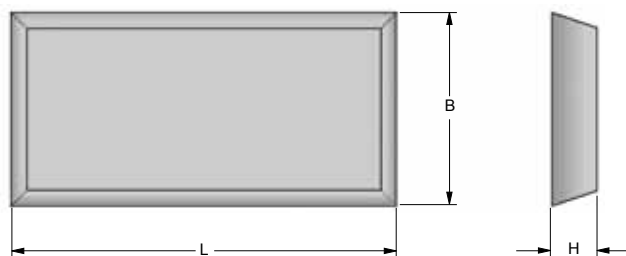

Chemical Composition (U.S.-Mil-A-1800 1 K)	
Al	0.10 - 0.50 %
Cd	0.025 - 0.07 %
Fe	0.005 % max.
Cu	0.005 % max.
Pb	0.006 % max.
Others	0.10 % max.
Zn	99.31 % min.
Potential Cu/CuSO <sub>4</sub>	-1.10 V
Capacity	780 Ampere hours per kg
Consumption	11.2 kg per Ampere year
Efficiency	95 %

All weights and dimensions are nominal and subject to variation in material compositions. Alternative configurations may be cast to requirements.

# SACRIFICIAL ANODES

## Aluminium anodes

Document No.: 05-300-R1

Sheet: 1 of 2

German Cathodic Protection



### Standard Aluminium Hull Anodes

Type	Anode weight kg	Aluminium weight kg	A mm	B mm	H mm	L mm
15 AI	1.5	1.1	220	100	30	300
25 AI	2.5	2.0	270	120	32	350
43 AI	4.3	3.4	370	120	32	450
60 AI	6.0	5.2	600	120	41	700
80 AI	8.0	7.5	350	150	62	450
90 AI	9.0	7.8	960	120	37	1060
114 AI	11.4	10.6	600	120	76	700
170 AI	17.0	15.8	960	120	73	1060
350 AI	35.0	31.6	1920	120	71	2000

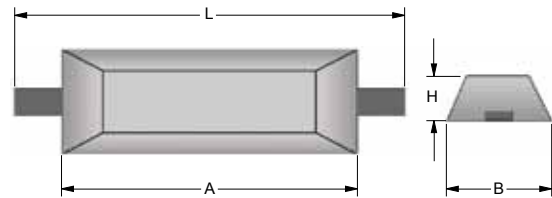

All types can be delivered for bolting. All weights and dimensions are nominal.

### Standard Aluminium Anodes - Static Structures

Type	Anode weight kg	Aluminium weight kg	A mm	B mm	H mm	L mm
280 HAL	27.3	21.5	1000	112	90	1500
385 HAL	37.7	30.0	1400	112	90	2000
485 HAL	47.7	40.0	1450	130	100	2000
516 HAL	51.6	40.0	2015	110	85	3000
566 HAL	56.6	45.0	2250	110	85	3000
585 HAL	57.7	50.0	1500	140	110	2000
616 HAL	61.6	50.0	2480	110	85	3000
625 HAL	62.5	54.8	1500	140	120	2000

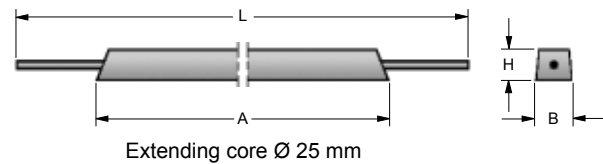

HAL Type anodes with variable lengths up to 2.5 m are available upon request. All weights and dimensions are nominal.

### Standard Aluminium Tank Anodes

Type	Anode weight kg	Aluminium weight kg	L mm	B mm	H mm	OH mm
44 TAL	4.4	3.8	400	70	60	140
96 TAL	9.6	8.5	750	77	65	135

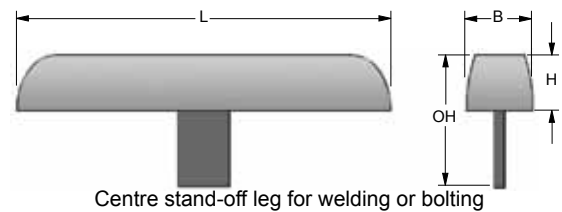

Type	Anode weight kg	Aluminium weight kg	A mm	B mm	H mm	L mm
100 TAL	10.0	8.7	1235	62	45	1415
125 TAL	12.5	11.2	1235	68	57	1415
200 TAL	20.0	18.4	1600	76	63	1780

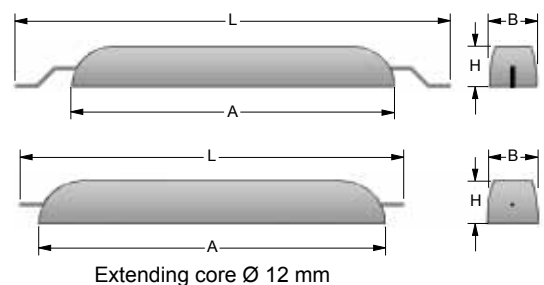

All weights and dimensions are nominal and subject to variation in material compositions. Alternative configurations may be cast to requirements.

# SACRIFICIAL ANODES

## Aluminium anodes

Document No.: 05-300-R1

Sheet: 2 of 2

German Cathodic Protection



Type	Anode weight kg	Aluminium weight kg	L mm	B mm	H mm	OH mm
105 TAI	10.3	8.7	1235	64	51	145
130 TAL	12.8	11.2	1235	68	58	145
160 TAL	15.7	13.7	1600	70	52	145
200 TAL	19.7	17.7	1600	76	63	145
230 TAL	22.6	20.0	2100	74	56	145
320 TAL	31.7	29.7	1600	95	84	165

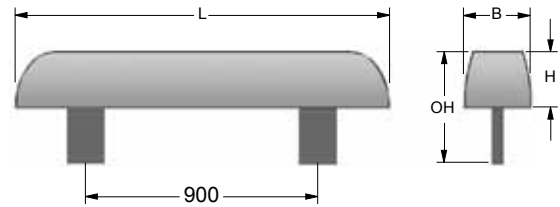

Centre stand-off leg for welding or bolting

All anodes can be manufactured with double cranked insert. Other anode types can be manufactured according to requirements or specifications. All weights and dimensions are nominal and subject to variation in material compositions. Alternative configurations may be cast to requirements.

Chemical Compositions and Electrochemical Properties		
	BERALIN ALLOY	BECALIN ALLOY
Zn	3.5 - 6.5 %	3.5 - 6.5 %
In	0.01 - 0.03 %	0.01 - 0.03 %
Mn	0.01 % max.	0.1 - 0.25 %
Fe	0.13 % max.	0.22 % max.
Si	0.10 % max	0.10 % max.
Cu	0.006 % max.	0.01 % max.
Al	remainder	remainder
Closed circuit potential	-1100 mV vs Ag/AgCl	-1120 mV vs Ag/AgCl
Current capacity	max. 2680 Ah/kg	max. 2550 Ah/kg
Efficiency	90 %	86 %
Consumption	3.27 kg per A/year	3.45 kg per A/year
Special advantages	High current capacity, especially suited to applications where low anode weights are desirable, e.g. offshore structures.	High driving voltage, especially suited to applications where water resistivity precludes the use of standard aluminium alloy.

## SACRIFICIAL ANODES

### Ribbon anodes



Document No.: 05-400-R1

Sheet: 1 of 1

German Cathodic Protection



### Magnesium Ribbon Anodes

MAGNESIUM		
Code	3.4 MR	2.8 MR
Section	9.5 x 19 mm	9.5 x 19 mm
Core diameter	3 mm	3 mm
Weight	0.34 kg/m	0.28 kg/m
Coil length	304 m	304 m
Packing	Steel-banded random wound open coils	Steel-banded random wound open coils







MAGNESIUM	
Composition	%
Al	0.01 max.
Mn	0.5 - 1.30 max.
Fe	0.03 max.
Cu	0.02 max.
Ni	0.001 max.
Other (each)	0.05 max.
Total of all others	0.30 max.
Mg	remainder
Potential Cu/CuSO <sub>4</sub>	-1.75 V
Max. capacity	1290 Ah / kg

### Zinc Ribbon Anodes

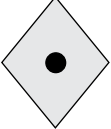
Plattline I is an alloyed zinc product generally used in seawater or brackish water environments.

Plattline II is a high purity product generally used in freshwater environments.

ZINC				
Code	Super	Plus	Standard	Small
Section	1" x 1-1/4"	5/8" x 7/8"	1/2" x 9/16"	11/32" x 15/32"
Core diameter	0.185"	0.135"	0.130"	0.115"
Weight	3.57 kg/m	1.79 kg/m	0.89 kg/m	0.37 kg/m
Coil length	approx. 30 m	approx. 60 m	approx. 150 m	approx. 300 m
Packing	Steel-banded random wound open coils	Steel-banded random wound open coils	Wood reels	Wood reels

ZINC	
Alloys :	
Plattline™ I meets the chemical requirements of MIL-A-18001K and ASTM B418-95a Type I	
Plattline™ II meets the chemical requirements of ASTM B418-95a Type II	
Potential Cu/CuSO <sub>4</sub>	-1.10 V
Max. capacity	780 Ah / kg



Extruded flexible ribbon anodes with continuous steel core.

All dimensions and weights are nominal.

Longer coil lengths are available on request.



**Bracelet anodes for submarine pipelines**

For submarine pipeline protection, both half shell and segmented bracelet anodes can be used.

Available in a range of standard sizes from 4 inches to 48 inches diameter with weights from 10 kg to 1000 kg. Sufficient standard moulds are always available to guarantee short lead time production. Bracelet anodes can also be manufactured to any practical design.

It is our recommended practice that the adequate steelwork forms part of any pipeline design to ensure that the anodic material is well supported in later life, so ensuring continued protection of the pipeline.

The outer diameter of the bracelet is specially designed to coincide with the outer diameter of the pipeline coating.

The choice of anode material depends on a number of parameters such as:

- coating material
- current requirements
- seabed resistivity
- temperature

<b>ALUMINIUM - GALVALUM III ALLOY</b>	
Composition	%
Fe	0.12 max.
Si	0.08 - 0.21
Zn	2.00 - 4.00
In	0.01 - 0.02
Cu	0.006 max.
Others (each)	0.02 max.
Al	remainder
Potential Cu/CuSO <sub>4</sub>	-1.15 V
Capacity (Sea-water)	2700 Ah / kg
Capacity (Mud)	1800 Ah / kg

<b>ZINC - US MIL SPEC 18001J</b>	
Composition	%
Cu	0.0005 max.
Al	0.10 - 0.50
Fe	0.005 max.
Cd	0.025 - 0.070
Pb	0.006 max.
Others (total)	0.10 max.
Zn	remainder
Potential Cu/CuSO <sub>4</sub>	-1.05 V
Capacity (Sea-water)	780 Ah / kg
Capacity (Mud)	730 Ah / kg

SEMI-CYLINDRICAL BRACELET ANODE

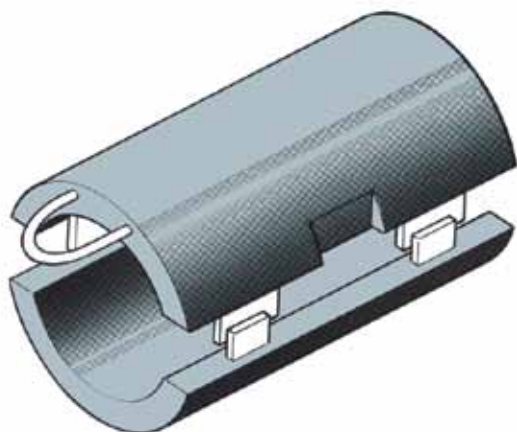

MULTISEGMENTED BRACELET ANODE

